



COMPACT DISINFECTION UNIT

CDU

MODEL : EOS7131 - CD

Operator's Manual

En

- Blank Page -

Preface Foreword Introduction

Described in this manual is the BioSure Professional CDU – Compact Disinfection Unit with model and version of engineering detailed as follows:

Product Code	Model No.	Program Code
CDU	EOS7131-CD	V209

BioSure is a division of Biotek Environmental Science Ltd. ("BES"). BES is a global leading electrolytic technology developer and product manufacturer with pioneering ozone application knowledge and currently holds many exclusive patents for its electrolytic ozone generators and products worldwide.

Copyright Information

© 2021 BES Group

All Rights Reserved.

Reproduction, adaptation, or translation without prior written permission is prohibited, except as allowed under the copyright laws.

Manual Number: Third edition, November 2021

Warranty

The information contained in this document is subject to change without notice.

BES shall not be liable for any direct, indirect, incidental, consequential, or other damage alleged in connection with the furnishing or use of this information. BES is not liable for damages on any contact materials due to result of oxidation.

BES makes no warranty of any kind with respect to this information. BES SPECIFICALLY DISCLAIMS THE IMPLIED WARRANTY OF MERCHANTABILITY AND FITNESS FOR A PARTICULAR PURPOSE.

- Blank Page -

TABLE OF CONTENTS

INTRODUCTION	5
PACKAGE CONTENTS	6
IMPORTANT SAFETY INSTRUCTIONS	7
SECTION 1 - General Information	
1.1 Description	10
1.2 Specifications	11
SECTION 2 – System Overview	
2.1 Getting to Know Your CDU	12
2.2 Control & Display	13
SECTION 3 – Getting Started	
3.1 Installing Your CDU	18
3.2 Starting Your CDU	28
3.3 System Shut-Down & Re-Start	29
3.4 Transportation and Relocation	29
3.5 Principles for Correct & Proper Use	30
SECTION 4 – Operation & Conditions	
4.1 Operation Principle	31
4.2 Operation States & Instructions	32
4.3 Other Functions	34
4.4 Validation	35
SECTION 5 – Maintenance & Service	
5.1 System Servicing	36
5.2 Troubleshooting	38
5.3 System Background Platform	41

INTRODUCTION

Congratulations on the purchase of your new BioSure CDU – Compact Disinfection Unit! Our CDU is surely the right choice for enhancing your Infection prevention and control in many preparation steps. You can be assured your CDU was constructed and designed with quality and performance in mind. Each component has been rigorously tested to ensure the highest level of acceptance.

This operator's manual was compiled for your benefit. By reading and following the simple safety, installation, operation, maintenance and troubleshooting steps described in this manual, you will receive years of trouble free operation from your CDU. The contents of this manual are based on the latest product information available at the time of publication. BES Group reserves the right to make changes in the content at any time without notice.

Immediately write in the serial number of your BioSure CDU system in the space provided below:

SERIAL NUMBER _____

Upon delivery, unpack the machine carefully and inspect it to ensure it was not damaged during shipment. If damage does exist, retain the original packing materials and then immediately file a claim with the transportation company and your BioSure dealer. Be sure that the mechanical and electrical problems are corrected prior to operation of the unit. If you require service, contact BES Group Customer Service.

CONTACT CUSTOMER SERVICE
for the Sales or Service Center nearest you!
product@besgroups.com

Please have the following information available for all service requests:

1. Model Number
2. Serial Number
3. Date and Place of Purchase

Please read all safety warnings carefully before using the product, especially the following sections: "IMPORTANT SAFETY INSTRUCTIONS" and "GENERAL INFORMATION". These sections provide very important information concerning the safety and proper operation of the unit. However, in order to feel assured you have gained a good grasp of every feature provided by your new CDU, the Manual should be read in its entirety.

Please always keep the manual handy for easy reference and note that:

- We are not responsible for any accidents and/or malfunctions due to improper use of this product.
- Please refer to this manual often when you have questions during the use or when troubleshooting this unit.

PACKAGE CONTENTS

Your CDU comes with the following items. As soon as you open the package, please check that all these items are present.

If anything is missing, please contact your dealer.

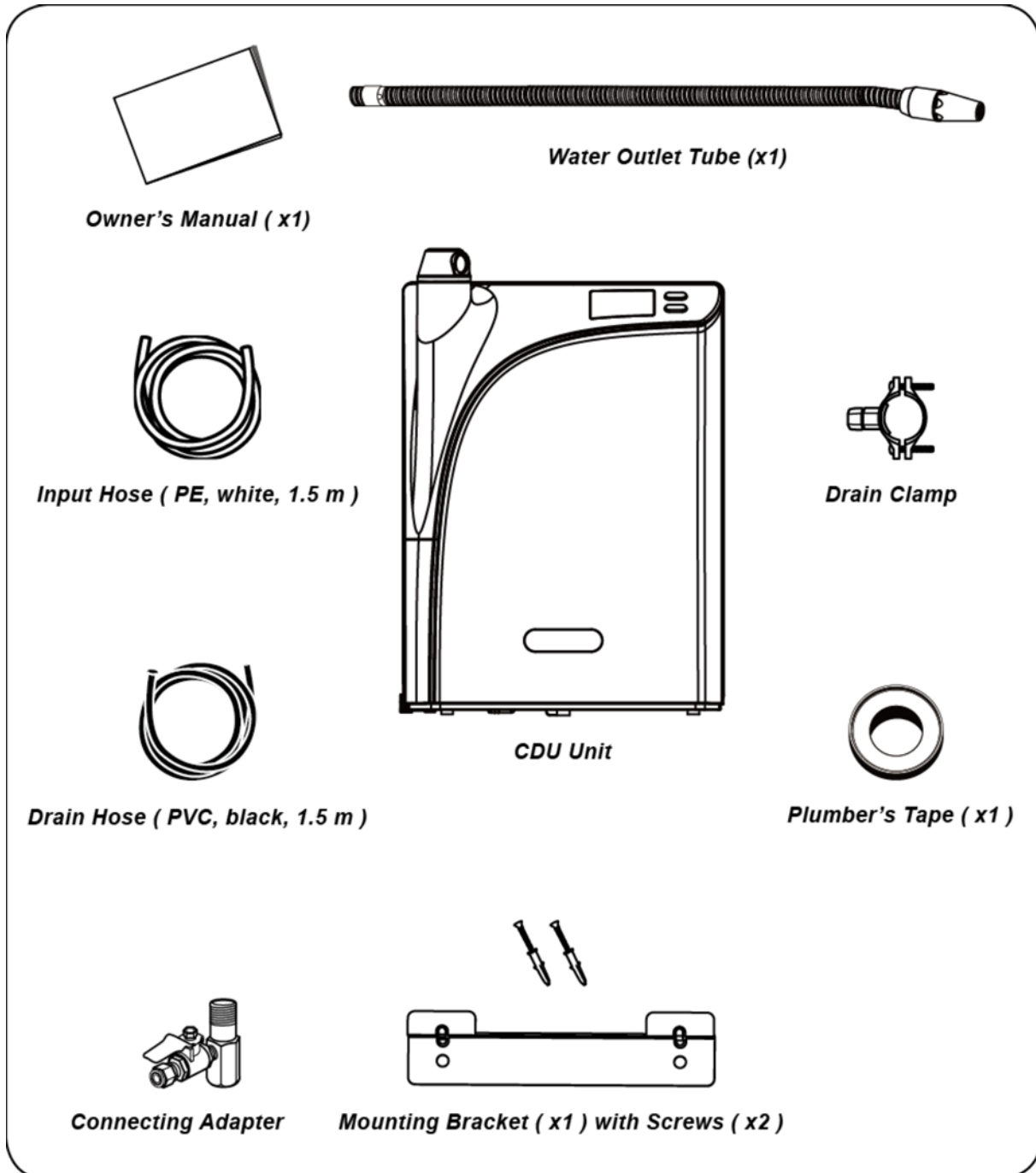

IMPORTANT SAFETY INSTRUCTIONS

READ ALL SAFETY WARNINGS & INSTRUCTIONS CAREFULLY BEFORE ATTEMPTING INSTALLATION & OPERATION

WARNING

Please read these pages carefully. They contain very important information to protect you and your valuable warranty on CDU. Make sure you are familiar with all the following safety warning and precautions associated with the unit.

DANGER

- ✓ Could cause personal injury or have adverse effects on health.
- Poor water quality may have negative effects on people health and your CDU! It is recommended that you use potable municipal water as source water (raw water).
- Do not move the unit by the front cover. Move the unit by putting both hands underneath it. This will prevent the unit from falling during movement.

CAUTION

- ✓ Could cause damage to CDU and possibly void your warranty.
- ✓ Risk of Fire and Electric Shock.
- If on hard water please ask about pre-treatment options. Your CDU is not under warranty for any damage or required cleaning by hard or poor quality water deposits.
- Failure to install or operate in accordance with the instructions described in this manual could void warranty and result in injury or product damage.
- To protect the unit and maintain the performance, power supply **MUST** be connected at all times! The unit **MUST** be stayed power-on at all times even not in use!
- Never run hot water through this unit. Connecting it to a hot water (>40°C) source could damage the EOG or other parts.
- Considering the core technology of this product, stabilization of electrolytic ozone generator (EOG), it relies greatly on a steady supply of electricity. Efforts should be made in order to try to avoid any or many incidents of man-made power off. The product's limited warranty does not cover any damage to the EOG parts due to frequent power off operations.
- Protect your CDU from freezing temperatures or from direct sunlight.
- Keep the unit and the power cord away from hot surfaces or appliances – failure to do so may result in electric shock or fire!

- To reduce the risk of electric shock, do not remove cover; no user-serviceable parts inside. Always refer servicing to qualified service personnel. Remove the cover will void the warranty.
- Do NOT try to fix the unit yourself! All service or repairing work must be performed by an authorized and qualified technician.
- All plumbing should be completely set up before plugging power to power on.
- Ensure all water inlets and outlets are connected to corresponding hoses and are properly installed.
- To protect your investment, if the input water pressure may exceed 7.0 kg/cm² (100 psi), a flow pressure regulator must be installed prior to input.
- Always make sure that all the connecting hoses allow free flow of water during operation.
- Ensure the power supply meet the requirements as indicated in the product specifications. Follow all applicable electrical codes.
- Risk of electric shock. Always use a well-grounded, 15A or above individual socket. Do NOT use loose or defective socket.
- To prevent accidental shock we recommend this product always be used on a GFCI (Ground Fault Circuit Interrupter) outlet.
- Risk of electric shock. Do NOT put the machine in water or spray water into it. Otherwise it may damage the unit or cause electric shock.
- Do not pull the power cord. Never touch power cord or power outlet with wet hands.
- Do NOT use a damaged power cord. Do NOT stretch, twist or tie power cord during use. Do NOT press power cord.
- In the event that water gets into power supply, unplug the power cord and completely dry power outlet.
- Do NOT operate the system if:
 - The cord or plug is damaged.
 - There is no input water supply.
 - The system has malfunctioned.
 - There is any noticeable damage to the system. Contact your regional distributor or authorized service agency for examination, repair or replacement.
- **WARNING** – To reduce the risk of electric shock, replace damaged cord immediately.
- Do NOT block the vent at the back of the machine, as this will impair the efficiency of the system.
- Do not use the unit in a dusty place. This may cause the unit to malfunction.
- Do not spray water on the main unit. Do not clean with a damp cloth or any chemicals, which may leak into the unit.
- Do not place this unit on an uneven surface. Do not drop or use excessive force on this unit.
- Do not poke or scratch the touch pad or LCD display with sharp objects.

- The system should always be sized appropriately for its intended use by a qualified professional familiar with the application.
- In case water leaks out of the unit (other than hoses) or unit is standing in a puddle of water, shut off the water supply, unplug the power cord and refer servicing to qualified service personnel.
- In case of strange noises, burning odor or smoke, unplug the power cord immediately and refer servicing to qualified service personnel.
- Replace EOG pre-filter at least every 12 months to optimize the purification performance of this unit even if the replacement indicator light isn't turned on.
- Keep original packaging for storage or unit transportation.

These safety precautions and warnings are provided at YOUR benefit to your safety and investment, for the safe and proper use of this unit and can prevent danger, bodily harm and/or possible damage due to misuse. Please make sure you are familiar with all the safety precautions and warnings associated with this unit. BioSure is not responsible for any damage or injury caused by not adhering to these precautions and warnings.

SAVE THIS MANUAL FOR FUTURE REFERENCE

**READ ALL SAFETY WARNINGS & INSTRUCTIONS CAREFULLY
BEFORE ATTEMPTING INSTALLATION & OPERATION.**

1. General Information

1.1 Description

BioSure CDU system is a disinfection system with ozonated water in supply designed specifically for infection prevention and control, offering the benefits of ozone in cold water in an effective and safe manner for integration with, and improvements of applications in your disinfection protocols. We take our commitment to quality seriously in order to ensure we are providing the highest standard of quality ozone disinfection solutions available.

The BioSure CDU system incorporates electrolytic ozone generation technology with electronic control and full-time performance monitoring. We provide concentrated ozonation treatment into water that flows through our systems, so as to provide for your applications with dissolved ozone in water at effectively high levels. With stabilized ozone production and constant dissolution capacity, the concentrations of dissolved ozone can be guaranteed, ensuring the given water flow with dissolved ozone levels on demand at "Right on Spec" performance to your applications.

The CDU system can be used to support and assist in a wide range of major applications in infection prevention and control, enabling disinfection professionals to reduce or replace harsh chemicals. With cold-water only and by the power of dissolved ozone in water, a complete solution is offered to you not only for bacteria free and chemical free, but also for a complete solution for your needs in improving infection control and risk management through our effective system!

Recommendable applications for CDU

Applications (Including but not limited to)	Suggested Conc. ppm (Dissolved Ozone)	CDU Performed Flowrate
Tools disinfection pre-wash	4.0 ~ 8.0	100 LPH (0.4 GPM)
Hand disinfection wash	4.0 ~ 6.0	
Terminal Disinfection	3.0 ~ 4.0	200 LPH (0.9 GPM)
Oral rinse water	1.0 ~ 2.0	
General Surface Disinfection	1.0 ~ 2.0	
Bacteria-free water for bottle	0.5 ~ 1.0	
Standards apply: BES Company Standard and Recommendations		

Note: Consult your local BioSure dealers for specific application recommendations.

1.2 Specifications

Model: EOS7131-CD		
Engineering Configurations		
Type of Ozone Generators	electrolytic ozone generator (EOG)	
Ozone Generation Source	Water (municipally treated water)	
Principle of Setup	Stationary Point of Use (POU)	
NO _x Concentration	0%	
Off-gas handling	Built-in catalytic process	
Cooling Configuration	Air cool	
IP Code	IPx2	
Noise Level	Max. 40 bBA (at 1 m or 3.3 ft)	
Output Feature		
Output	Ozonated water	
Flow Capacity (LPH)	Boost Output	Standard Output
	100 LPH (0.4 GPM)	200 LPH (0.9 GPM)
Concentration*(ppm)	10.0 ~ 1.0	6.0 ~ 0.6
Outflow Pressure	≤ 0.3 kg/cm ² (4.3 psi)	
PH	Does not change the source water pH value	
Power Requirements		
Applied Power	AC 100 ~ 240 V / 60 ~ 50 Hz	
Rated Power	In Use	≤ 60 W
	Standby	≤ 30 W
Input Water Requirements		
Pressure	3.0 ± 1.0 kg/cm ² (42.7 ± 14.2 psi)*	
Flow Rate	≥ 300 LPH (1.3 GPM)	
Temperature	5 ~ 40 °C (41 ~ 104 °F)	
Water Quality	Municipally treated tap water, pH: 6 ~ 8; TDS <300ppm / Conductivity < 500 μ s/cm	
* Recommended pressure; if the input water pressure may exceed 7.0 kg/cm ² (100 psi), a flow pressure regulator must be installed prior to input.		
Dimensions and Weight		
Dimension	mm	300 x 165 x 400
(WxDxH)	inch	11.8 x 6.5 x 15.8
Net Weight	Kg	7.5 (around 9.5 kg when filled with water)
(Approx.)	lb	16.5 (around 21 lbs when filled with water)
Location Requirements		
Location	For use on a hard, level, and stable surface only	
Ambient Temperature	5 ~ 40 °C (41 ~ 104 °F)	
Ventilation	Min. 5 air changes per hour	
Clearance	Min. 10 cm (4") clearance around unit	

2. System Overview

2.1 Getting to Know Your CDU System

Front View

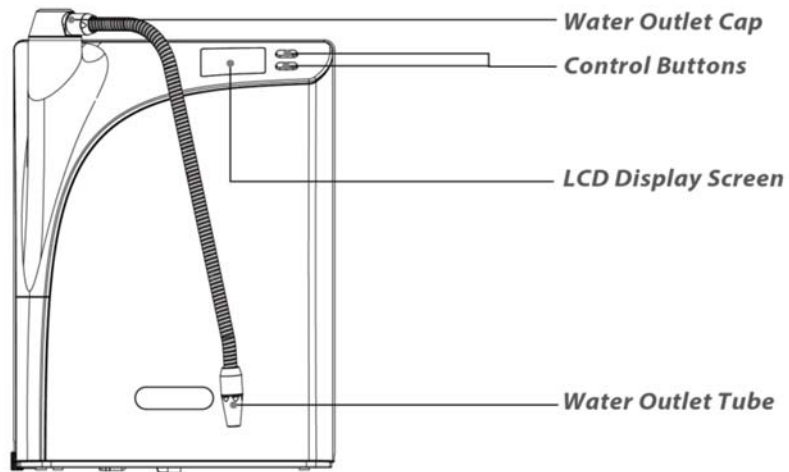

Back View

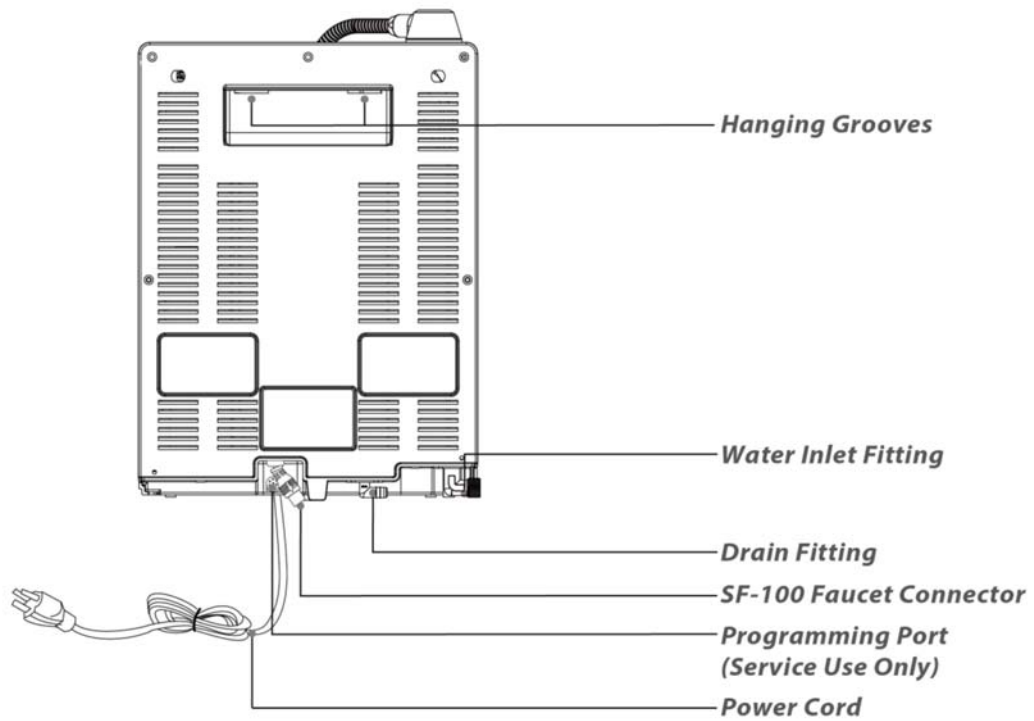

2.2 Control & Display

Control Sensor and Button

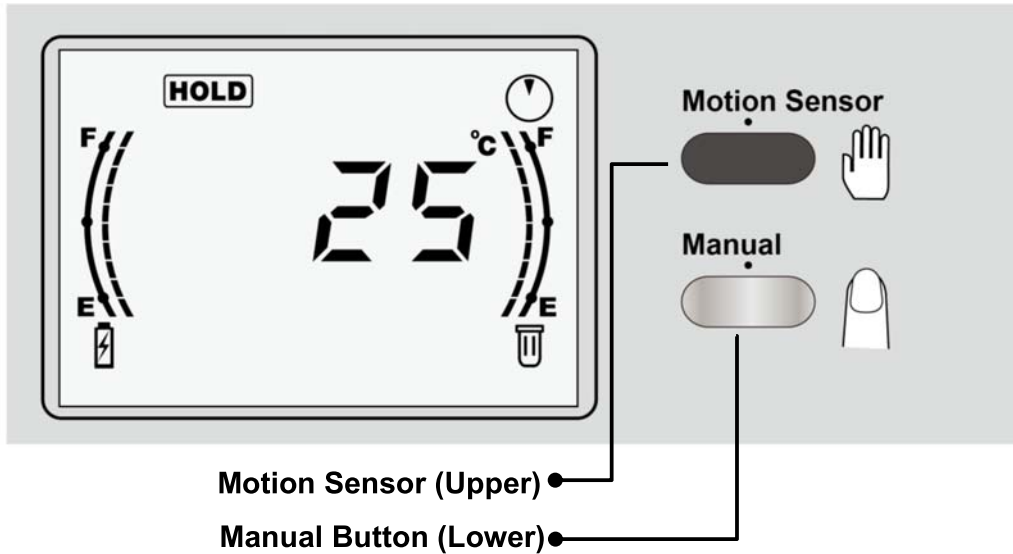

Sensor & Button Functions

Boost Output - For reinforcement and acceleration effects

Activate this function will give an output with flow rate at **100 LPH (0.4 GPM)** and dissolved ozone concentrations ranging **10.0 ~ 1.0 ppm** with output time length 5 min.

Control	Method to Start	Buzz Sound (Beep Number)
Motion Sensor (Upper)	Sense 0.7 sec	Once
Manual Button (Lower)	Press 0.2 sec	Once

Note : A LIGHT PRESS is all that is required when pressing the lower button. If any of the button or sensor is not activated during the output operations, the system will automatically stop giving the output after 5 minutes.

Standard Output - A larger flow for general disinfection rinse

Activate this function will give an output with flow rate at **200 LPH (0.9 GPM)** and dissolved ozone concentrations ranging **6.0 ~ 0.6 ppm** with output time length 5 min.

Control	Method to Start	Buzz Sound (Beep Number)
Motion Sensor (Upper)	Sense 3.0 sec	Twice
Manual Button (Lower)	Press and hold 1.0 sec	Twice

Note : If any of the button or sensor is not activated during the output operations, the system will automatically stop giving the output after 5 minutes.

For directions of use and further information about applications, refer to Section 4.2.

Display Screen Guide

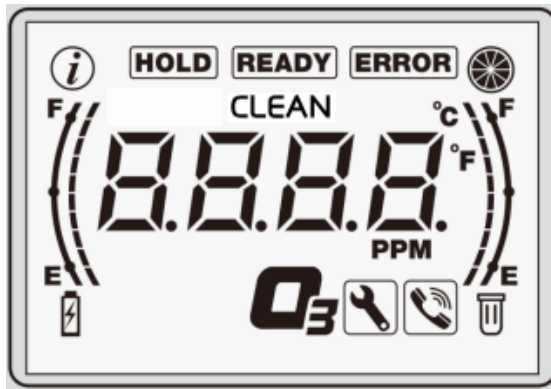

- | | | | | | |
|--------------|---|----------------------|--------------|---|-----------------------------|
| HOLD | - | Waiting Indicator | READY | - | Ready Indicator |
| ERROR | - | Error Indicator | | - | Performance Meter |
| | - | Output Feature | CLEAN | - | Internal Cleaning Indicator |
| PPM | - | Output Concentration | °C/°F | - | System Temperature |
| | - | Service Indicator | | - | Call Customer Service |
| | - | Status Alert / Info | | - | |







8.8.8.8 - 4-digit Numbers or Signs for Information Displaying.







- Life Meters for EOG (Left) and Pre-Filter (Right)

Display Feature – Conditions & Interpretations

	- Status Alert / Info
Mode	Descriptions
Flash	If the flashing "" icon is present, it is meant to: Notify the user of when the monthly bottom line of the incident of power off has been reached (the 6 th times in the month). * To maintain system's performance, power must be ON at all times. To keep the warranty valid, power off should not exceed 72 times in a year (6 times per month – monthly bottom line).
Display	The "" icon is present when user enter the System Background Platform.

 - Performance Meter	
Mode	Descriptions
	<p>The performance icon shows the performance charge level, from full  to empty  when using continuously, filling to full in standby. When the meter shows that every segment is filled, the system is ready with peak performance on standby. It takes 30-60 minutes for the unit to recharge performance level from baseline to peak.</p>
Full / Empty	<div style="display: flex; justify-content: space-around; align-items: center;"> <div style="text-align: center;">  Full </div> <div style="text-align: center;"> <p>Performance at peak</p> </div> <div style="text-align: center;">  Empty </div> <div style="text-align: center;"> <p>Performance at baseline</p> </div> </div>
Flash	<div style="text-align: center;">  Blink </div> <p>Consuming or recharging performance</p>
HOLD - Waiting Indicator	
Mode	Descriptions
	<p>When the waiting icon HOLD is present, it indicates to wait for certain amount of time before functions become available. This waiting can happen during two modes of process:</p>
Display	<p>1) First time start-up – The waiting icon will stay on until system preparation gets ready (30 to 45 minutes).</p>
Flash	<p>1) Re-start system – The waiting icon will remain flashing until a compulsory time out period is finished (30 minutes).</p> <p>2) The unit is under internal cleaning.</p>
READY - Ready Indicator	
Mode	Descriptions
Display	<p>The ready icon READY shows the system is ready, and the system's output functions are available for use.</p>
Flash	<p>The icon flashes when user entered the system background platform</p>

ERROR	- Error Indicator
Mode	Descriptions
Flash	<p>When the system displays an error icon ERROR that flashes quickly, this means there is an error or problem that has caused the system to stop running. Conditions which can attribute to an error result could include the following:</p> <ol style="list-style-type: none"> 1) Water Input Failure (EOG water refilling timeout). 2) Consumables end of service life. 3) Faulty EOG cell.
°C/°F	- System Temperature
Mode	Descriptions
Display	By considering appropriate operating conditions, system temperature is measured and displayed for user's reference during the unit is on normal standby. Standard display is in degrees Celsius; degrees Fahrenheit is optional.
O₃	- Output Feature
Mode	Descriptions
Display	The icon is displayed during output operations.
CLEAN	- Internal Cleaning Indicator
Mode	Descriptions
Display	CLEAN shows that the system is processing internal cleaning. All functions are suspended.
PPM	- Output Concentration
Mode	Descriptions
Display	For convenient application and operator's reference, the output concentrations are simulated by the system and the readings are displayed during output operations. The ppm icon represents the unit commonly used for dissolved ozone concentration, expressed in ppm (parts per million, equivalent to mg/L).

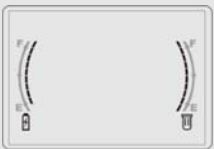
	- Service Indicator
Mode	Descriptions
Display Flash	<p>When the service icon  is present, it indicates the system requires a service.</p> <ul style="list-style-type: none"> • Consumables end of service life. • Consumables near end of service life.
	- Call Customer Service
Mode	Descriptions
Display	<p>This is an indication that at this point the operator should contact the local customer service for troubleshooting. The phone icon will be displayed together during:</p> <ol style="list-style-type: none"> 1) Error conditions: Faulty EOG cell [E10], Water Input Failure [E45], and Power disconnection exceeds limit. [E75]. 2) Consumables end of service life.
	- 4-digit Numbers or Signs for Information Displaying
Mode	Descriptions
Display	<p>The displayed numbers or signs help provide information to operators in 4 digits. It displays:</p> <ul style="list-style-type: none"> – System temperature while system is in standby mode – Concentration (ppm) while ozone water is in use – Error code while system error – Review results and settings
	- EOG cell
Mode	Descriptions
Flash	Power disconnection exceeds limit.
	- Life Meters for EOG (Left) and Pre-Filter (Right)
Mode	Descriptions
Display	<p>The life meters show the estimated life remaining level for the ozone generator and input water pre-filter.</p> <p>When there is only one segment left and flash slowly, the system chirps twice when using to remind user the part is near end of service life.</p>

3. Getting Started

Consult your local BioSure dealer for service of installation. The instructions described below for the installation is intended for operator's reference only. For an installed unit, see Section 4 for operation instructions.

3.1 Installing Your CDU

Location

The BioSure CDU is designed for setting up on countertop, wall-mount or under-counter. For countertop and under-counter setup, place the unit on a hard flat surface to prevent toppling or falling. For wall-mount, select a solid wall and apply the mounting bracket (accessory included) to secure the mounting.

Key criteria for location:

- Electricity supply nearly accessible (AC 100 ~ 240 V / 60 ~ 50 Hz).
- Municipally treated tap water nearly accessible (pH: 6 ~ 8; TDS <300ppm/ Conductivity < 500 μ s/cm).
- Cold water supply available (5 ~ 40 °C / 41 ~ 104 °F).
- Drainage available.
- Well ventilation - min. 5 air changes per hour.
- Able to allow sufficient access for maintenance and all piping.
- Climate-controlled, ambient temperature of 5° to 40°C (41° to 104°F).
- Out of reach of water splash and airborne water with a degree of protection from dirt or other containment.

Electrical

The BioSure CDU is supplied with a standard power cord. Plug the cord into a standard grounded, grounding type receptacle only. Refer to product specifications (see Section 1.2) and your local electrical codes for information on proper electrical connection. All permanent electrical connections should be attended by a qualified electrician.

Note: The circuit must be protected by a GFCI (Ground Fault Circuit Interrupter) installed in accordance with electrical codes.

Plumbing

Parts & Hardware included



- A. Water Outlet Tube
- B. Connecting adapter
- C. Input hose (3/8", PE, 1.5 m, white)
- D. Drain Hose (ϕ 7×10 mm, PVC, 1.5 m, black)
- E. Plumber's tape (Teflon tape)
- F. Drain clamp
- G. Mounting Bracket with Screws

Tools & Materials Required



- A. Safety glasses
- B. Phillips screwdriver, adjustable wrench and utility knife
- C. Tape measure and pencil or marker
- D. Pan or bucket and newspaper or towels
- E. Electric drill (cordless recommended)
- F. Other piping materials (depend on actual situation)

Optional Materials



- A. Hacksaw or Pipe cutter (for metal pipe)
- B. 6 mm drill bit (for creating holes for mounting bracket)
- C. 10 mm drill bit (for creating passing holes for piping)

Plumbing and Installation Instructions

Setup your unit and then plumb all the necessary water input, output and drain as in accordance with the "**Typical Scheme of Installation**" below or the "**Typical Installation Layout**" in Instruction 5. Follow all local plumbing and construction codes.

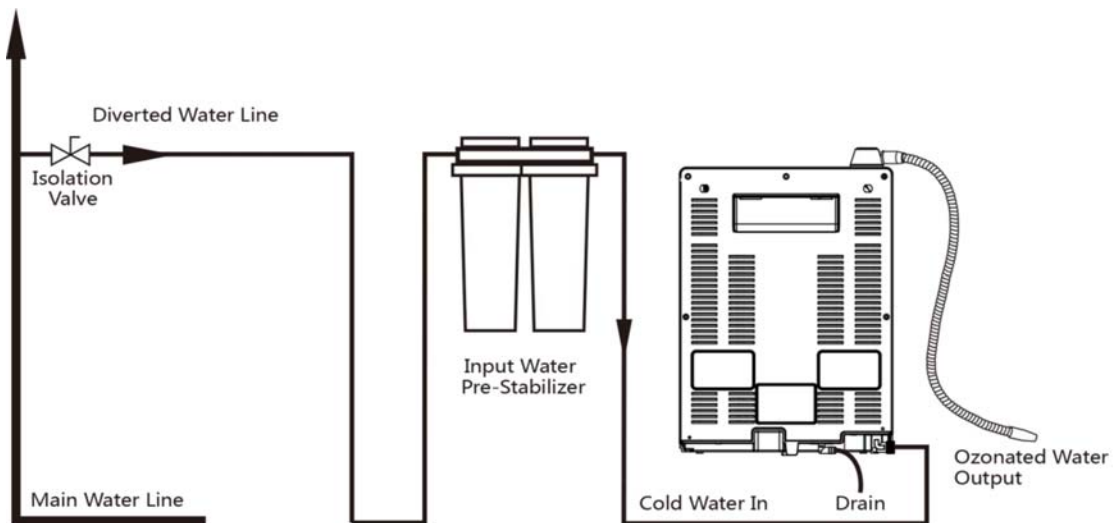

Typical Scheme of Installation

Instruction 1 - Counter Top or Under-Counter

Determine if you will place your unit simply with a counter-top setup or mount it above and/or near to a sink. To mount the CDU on the wall, please follow the directions below:

1. Drill two 6 mm holes in the wall 400 mm above the top of the sink or counter. The distance between the 2 holes must be 100 mm:
2. Press the plastic anchor inserts into the holes as pictured below. Push the plastic anchor insert so that the opening is flush with the wall.
3. Place the mounting bracket on the wall and fix with screws as pictured below. Hang the CDU on the mounting bracket.

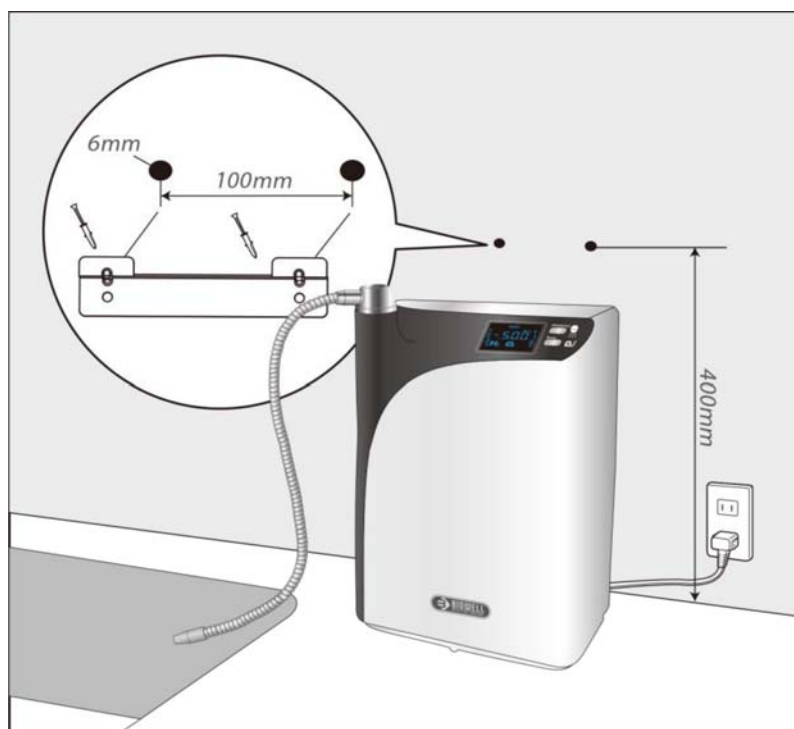

Important:

For counter-top installation, two 10 mm holes on the counter will be required for passing the input water and drain hoses through the surface. This is in order to allow the connections from the back of the unit to under sink area for input water and drain.

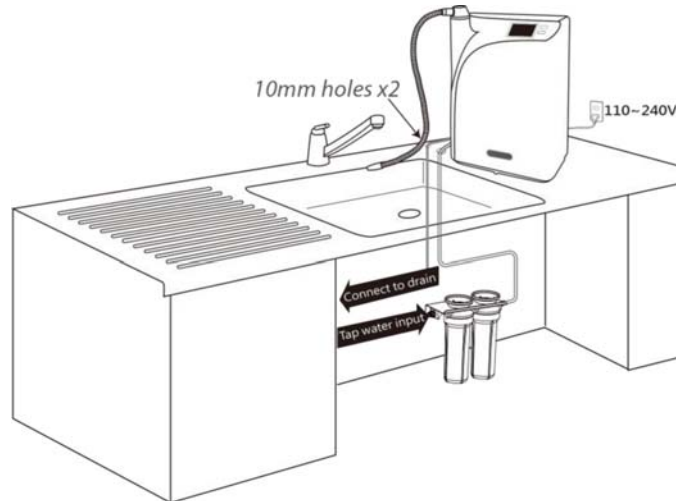

Instruction 2 – Input Water Setup

1. Remove the connecting adapter (diverter & valve) from the accessory kit and seal the threaded connection with thread tape:

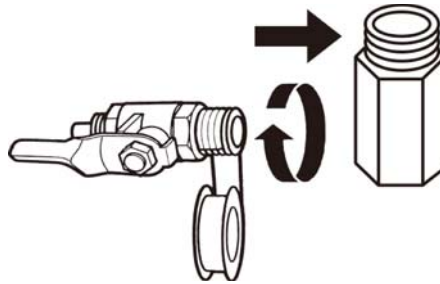

2. Locate the cold water supply under the sink. Shut off water supply.
3. Connecting the adapter to the cold water line between the wall and the sink faucet as follows:

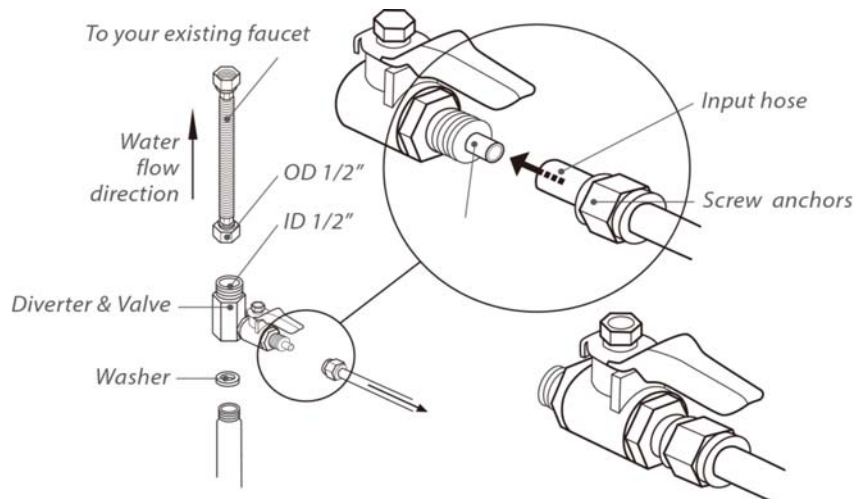

Instruction 3 – Setup Input Water Pre-Filter

1. Select an easy-to-access location near or under the sink for the input water pre-filter setup.
2. Determine if you will place the pre-filter simply on surface in a vertical position or mount it. To mount the pre-filter:
 - a. Using the built-in bracket on the back of the pre-filter head to mark the holes for mounting screws on the wall surface. Use a 6 mm drill bit to bore pilot holes into the marked positions or drive screws directly into the positions. This may require the use of toggle bolts to hold in dry wall.
 - b. Hang the pre-filter on the eyes of the bracket. This pre-filter head should be mounted to a firm wall surface.
3. Connect the water line from the adapter's valve outlet to the inlet of pre-filter. The outlet will be connected to the unit.

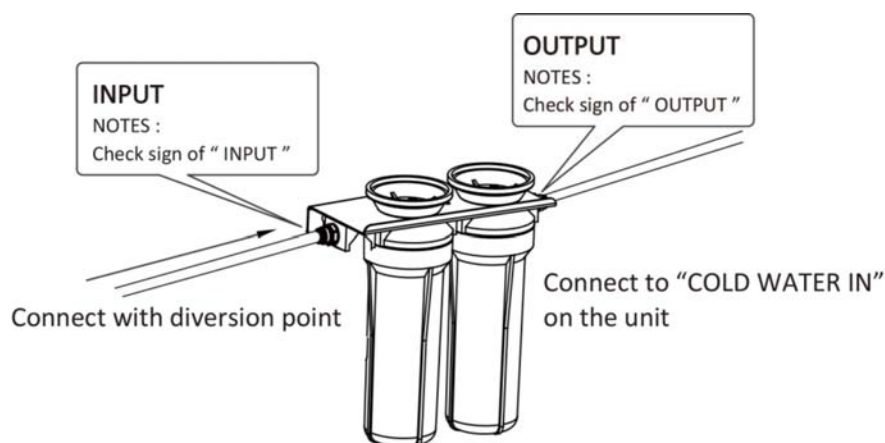

Note: In mounting setup, allow a minimum clearance of 10-15cm (4-6") below the pre-filter for further service. The pre-filter must be placed or mounted in a vertical position.

Instruction 4 – Input & Drain Connection

1. Remove the joint tube from the unit's inlet and outlet fittings on the back of the unit. This joint tube is used for shipping purposes only.
2. Remove the input hose (white) and drain hose (black) from the accessory kit.
3. Insert the input hose into the unit's fitting (COLD WATER IN). Tightly screw the nut onto the fitting to secure the hose into place. Then, attach the drain hose to the unit's drain fitting (DRAIN).

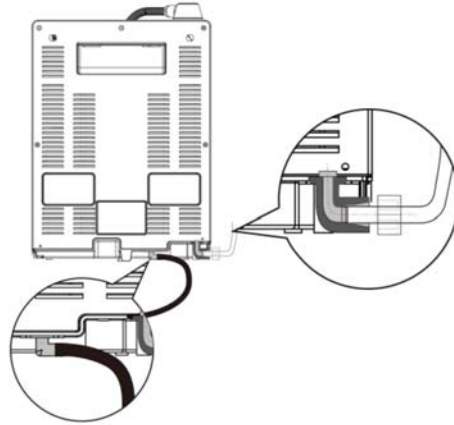

Insert and lock the Input water hose (white) into "COLD WATER IN" fitting (white). Attach the drain hose (black) to "DRAIN" fitting (black).

4. Setup your drain connection in two ways as follows:

Option A – Counter-Top Placement:

Two 10 mm holes on the counter will be required for passing the hoses (drain and input). Or you can attach the drain hose with a suction holder (not included) to your sink wall surface (ask from your dealer if preferred in this way).

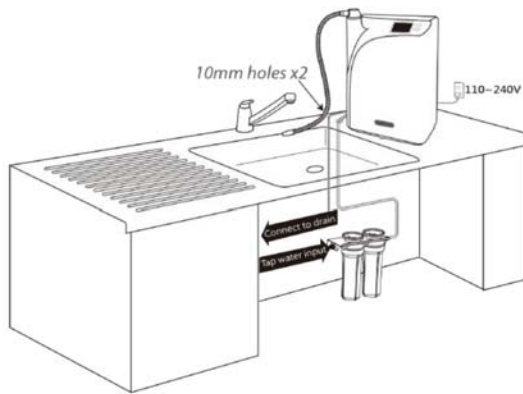

Pass the hoses through holes on the counter

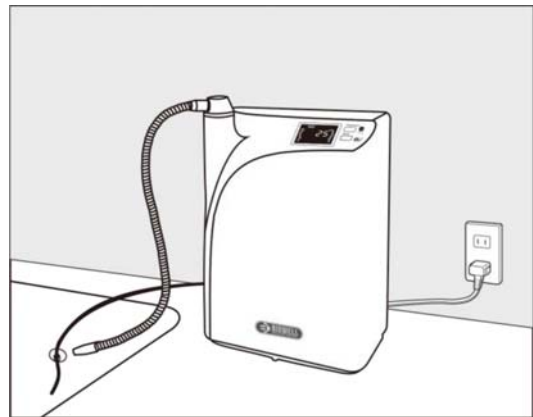

Attach the drain hose with a suction holder

Option B – Under-Counter Connection (recommended):

1. A 10 mm hole on the counter will be required for passing the drain hose.
2. Drill a 10 mm hole into the sink drainpipe and install the drain hose with the drain clamp (accessory kit included) in accordance with the below scheme.

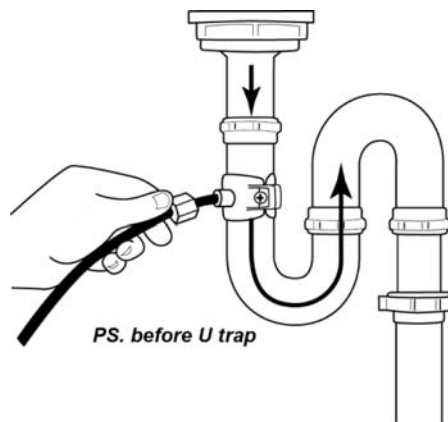

Instruction 5 – Connect Water Outlet Tube

To locate the water outlet, remove the plastic cap positioned at the top of the unit (rotating water output cap).

- a. For counter-top installation, find the flexible water outlet tube in the accessory box. Screw the tube anticlockwise into the water outlet until there is no gap. Do not over tighten.

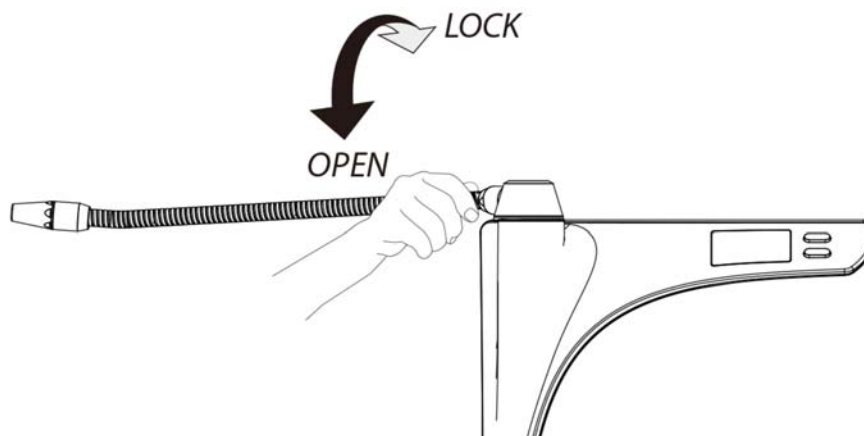

- b. For under-counter installation, a digital sensor faucet (Model: SF-100) designed exclusively for the unit will be required in order to accomplish the control of output from counter-top. Follow instructions below to install the SF-100 digital sensor faucet and connect it with CDU :

- 1) Drill a $\phi 32$ (mm) or $1\frac{1}{4}$ " hole in the sink or counter top or use the available hole.
- 2) Insert the faucet tailpieces with supply and connection line into the hole.
- 3) From beneath the sink or counter top, screw the lock nut onto the faucet tailpieces and tighten them with a basin wrench.

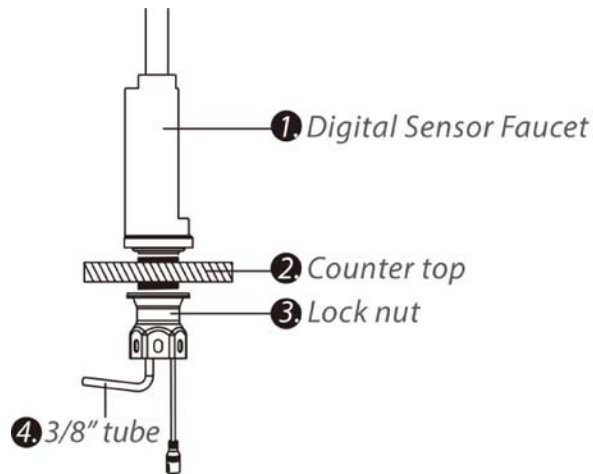

- 4) Connect the faucet and under counter unit and wire the waterproof connectors.

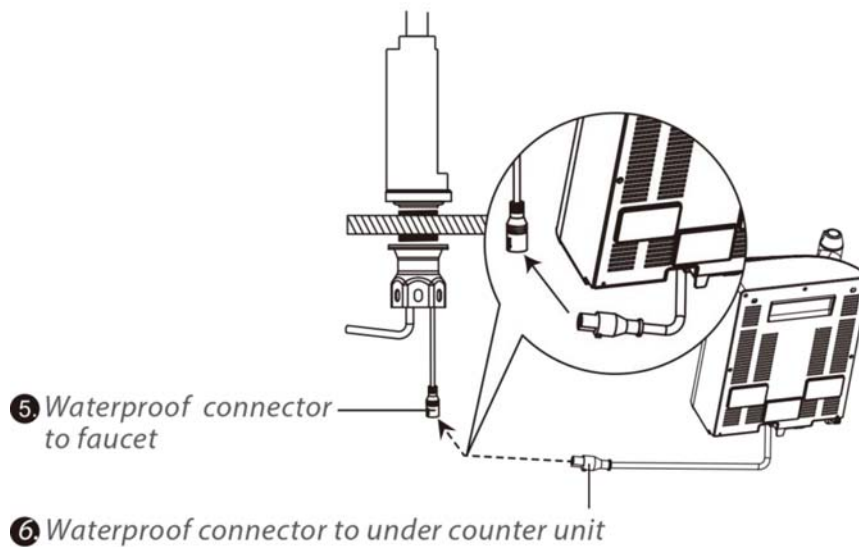

- 5) Connect the faucet and under counter unit and assemble the tubing as shown.

7. Unit water outlet cap
8. Faucet adapter and union converts M14 anti-clockwise thread to M14 clockwise (use the M14 anti-clockwise thread to connect to the unit water outlet cap)
9. Ferrule (for 7x9 mm tube)
10. M14 lock nut

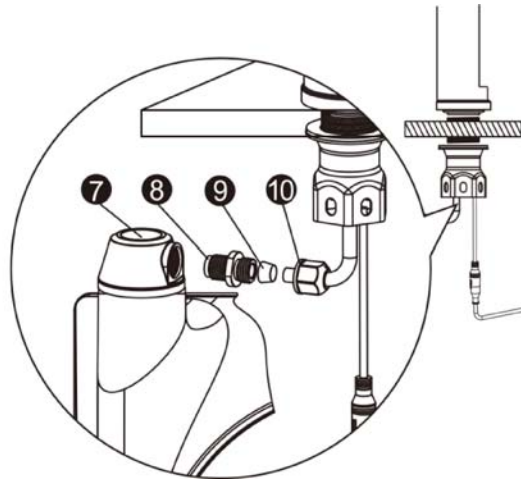

NOTE: The control panel of the main unit will be invalid after the faucet is connected.

Typical Installation Layout

Below drawing shows the installation and relevant plumbing as installed with a counter-top scheme:

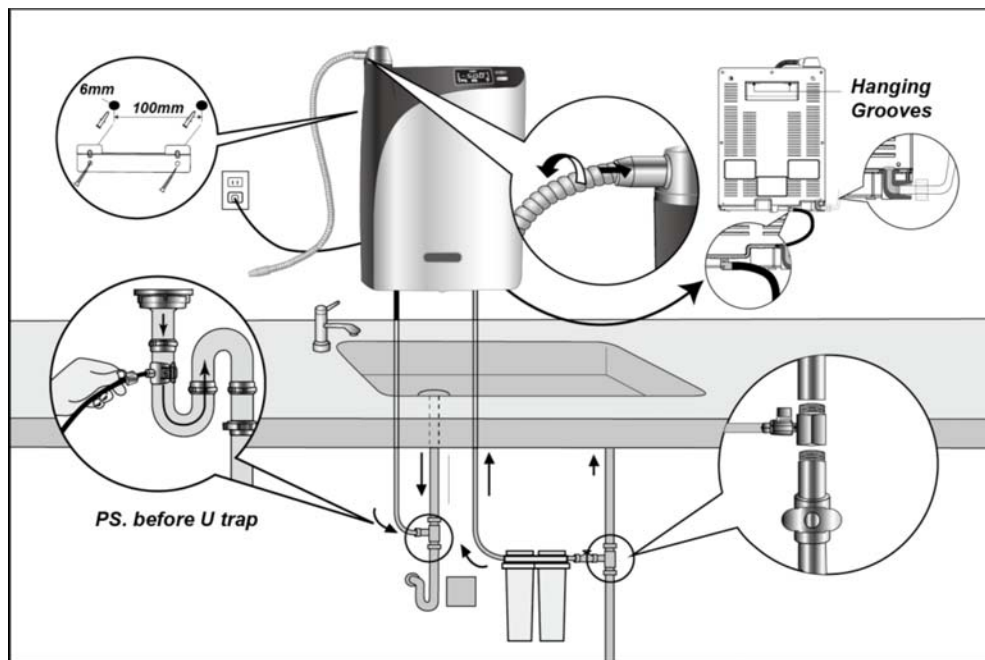

For under-counter installation, a digital sensor faucet (Model: SF-100) designed exclusively for the unit will be required in order to accomplish the control of output from counter-top. The CDU main device will be located under the sink. While the connections of the input water and drain are accessible directly under the sink, the outlet will be connected to the faucet for output.

Below drawing shows the installation and relevant plumbing schemes for under-counter installation:

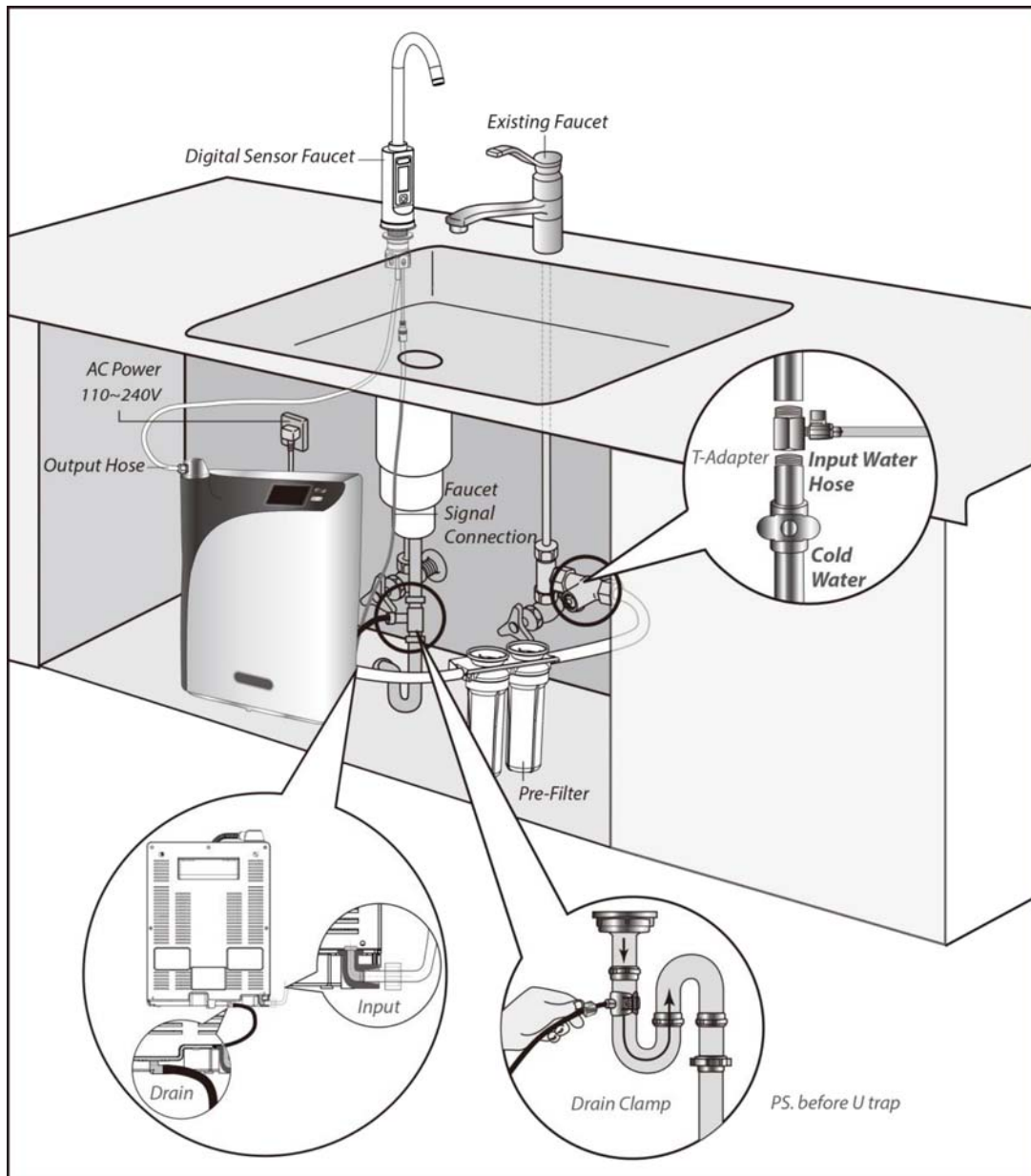

Note: These installation diagrams are for illustration and reference purposes only, indicating the required key components in the installation. Plumbing and setup orientation may vary from place to place.

3.2 Starting Your CDU

Confirm all below points prior to start-up:

1. All inputs, output and drain are correctly installed to their corresponding connections.
2. Ensure that the machine is connected to cold water supply input.
3. The power supply meets the requirements as indicated in the product specifications.
4. Input water pressure is less than 7.0 kg/cm² (100 psi), or within the recommended range: 3.0 ± 1.0 kg/cm² (42.7 ± 14.2 psi).
5. The area of operation is well ventilated.

First Time Start-Up

The unit is switched ON by plugging the cord into wall outlet (power supply). There is no ON/OFF control switch. Before plugging unit into wall outlet, all plumbing works should be completely set up.

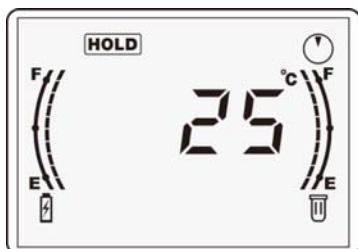

To use the machine at the first time, connect the unit to power to switch on and the system-preparing indicator "**HOLD**" will light up on the display panel. At this point, the unit is in preparation stage refilling water for EOG start-up. This process will take about 30 to 45 minutes depending on input pressure.

Note: *Draining during this stage is normal.*

- **System Ready Indication**



Once this preparation phase is complete, the "**HOLD**" will go out automatically, and "**READY**" will light up, indicating the unit is now ready for use. At this point, the panel shows the detected system temperature on the display screen.

- **Unsuccessful Start-Up**

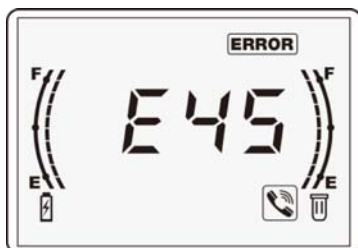

However, if in one hour the initial water filling process for EOG start-up cannot be completed, a " " error code will be displayed, indicating that the water filling process was unsuccessful. All functions will remain suspended. Please check the input water pressure and refer to the troubleshooting section if the symptom is identified.

3.3 System Shut-Down & Re-Start

Conditional Shut-Down

The CDU is intended for constant power-on, unless in necessary situations, such as before machine servicing activities. The following sequence of steps must be followed for manual shut-down:

1. Shut off water supply first.
2. Turn off the system by un-plugging the cord from the wall outlet.

Note: Disconnecting the power frequently may cause unexpected impacts on the EOG working module and result in degradation to the product performance.

Re-Start & 30 Minutes Re-Start Protection

The unit can be switched OFF by un-plugging the cord from wall outlet (power supply). Before shutting down the unit, the water supply to the unit should be completely turned off.

To re-start the unit, reconnect the unit to power to switch on. **In system re-starting, all functions are suspended for 30 minutes** along with "**HOLD**" flashing slowly. During this waiting period, maintenance program is running at background for self-check.

3.4 Transportation & Relocation

For safety reasons, be sure that the people who transport and handle the unit are informed about the machine specifications and information. Whenever possible, make sure the system stays in the upright position, and avoid damage to the hose connectors during transportation. Check all passages and spaces where the machine has to be transported through, they must have sufficient dimensions to meet the height and width of the machine (including the package before unpacking). Never push, pull or press the components protruding from the contour line of machine (water inlet and outlet pipes etc.).

Do not transport the machine in a way by which it can be exposed to environmental conditions or extreme humidity. The ambient temperature during transportation should always be maintained between 5 ~ 40 °C at all times.

For machine relocation, consult your local BioSure dealer for service arrangements.

3.5 Principles for Correct & Proper Use

As a result of proper use of the BioSure CDU system, unpleasant effects of traditional chemical use are virtually eliminated. The BioSure CDU system can be so reliable to you and is safe and harmless to your equipment or tools when installed and operated properly!

- The BioSure CDU system **MUST** remain connected to the supply of power and water **AT ALL TIMES**. This is because the stability and sustainability of the EOG's performance is highly reinforced by the continuance of connected power and water supply to the system.
- Power disconnection should always be avoided as far as possible unless necessary, for example, during machine servicing activities. Disconnecting the power or having power failure during operation of the unit at any time may cause unexpected impacts on the EOG working module and result in degradation to the ozone production performance. For desirable maintenance, instance of power disconnection should be managed within 36 times on an annual operation basis.

Note: In cases for locations where power lost can happen frequently, together in use of On-Line Uninterruptible Power Supply (On-Line UPS) is recommended.

The BioSure CDU system is intended solely to apply cold, municipal tap water as input for the operation. The key criteria considered for the quality of the input water are as follows (Refer to Section 1.2):

- Water conductivity below 500 $\mu\text{s}/\text{cm}$
 - Temperature between 5 ~ 40 °C (41 ~ 104 °F)
 - pH between 6 and 8
 - Municipally treated tap water
- Connecting to the water source with supply pressure at 3.0 kg/cm² (42.7 psi) is preferably recommended for the best system performance.
 - Ambient temperature around the system should be between 5° ~ 40°C (41°~104°F). If the system is installed in an environment with temperatures over 40°C (104°F), an additional air-cooling approach must be provided. Operating outside of the recommended temperature ranges may result in damage not covered under the product's warranty.
 - The system must be protected from freezing, which can cause cracking of the system's parts and water leakage.
 - The system may not be operated in conditions other than those described in this manual (Refer to Section 1.2).
 - The system is not intended for operation outside. However, if it is so necessary for outdoor installations, protection from weather elements (direct sun, rain, dirt) must be provided.
 - The system is not intended for portable operation but for stationary only.
 - The correct and proper operation of the system cannot be guaranteed if non-genuine parts or third party accessories are used.
 - Please read and observe the service requirements to keep the machine in good working order.

4. Operation & Conditions

4.1 Operation Principle

EOG Process for Professional Dissolved Ozone Generation

The CDU produces ozonated water at professional high levels for effective disinfection use.

Just exactly what is this? Your CDU employs computer accurate low-voltage electric current and selectable proton exchange energy to perform water electrolysis through patented ***Electrolytic Ozone Generator (EOG)***. Inside this advanced ozone generator, driving force from the electric current and proton exchange energy will split water into its basic elements – H₂, O₂ & O₃, and the process will then separate the hydrogen gas to leave oxygen and ozone as the only reaction products. This leads to the higher ozone dissolution in water because there is no other competing gas present in the output comparing to the traditional method that uses air as source.

This method of generation can achieve ozone concentrations of 20~30% in the output and is independent of air quality because water is used as the source of production.

EOG stabilization

The EOG requires water with low conductivity as the starting substrate. With a self-contained water treatment for water deionization inside the CDU, using typical tap water as the only feeding source for the system come factory-ready for you to attach the municipal water supply directly. The water required by the EOG is secured through our EOG stabilization module, including an external part for the treatment in the first phase (pre-filter), followed by a combined Reverse Osmosis (RO) and Resin Deionization (DI) process within the system to accomplish the requirement. The majority of ionic species present in the input water, which are responsible for the conductivity levels, will be removed through this stabilization process.

Off-gas handling & Ozone Practice Safety

Un-dissolved or excess ozone will be destroyed to form oxygen by separating and directing it through a built-in ozone destruct device before releasing it into the air. This destruct unit applies a catalytic method that is able to destruct the off-gas immediately.

4.2 Operation States & Instructions

For First Time Start-Up, System Shut-Down and Re-Start please see Section 3.2 and 3.3.

Note: The unit is switched ON by plugging the cord into wall outlet directly (power supply).

Output Operations

■ Counter-Top Operation

You can select two kind of output between “Boost Output” with immediately raised concentrations for reinforcement and acceleration effects and “Standard Output” with larger flow for general disinfection and rinse.

■ Boost Output

- For reinforcement and acceleration effects

When the performance icon  is full, the ozone water output with the highest concentration of 10.0 ppm can be supplied immediately (output concentration range: 10.0 ~ 1.0 ppm; flow rate: 100 L/hour), the continuous water output time is 5 minutes. Press or sense any button to stop giving the output.

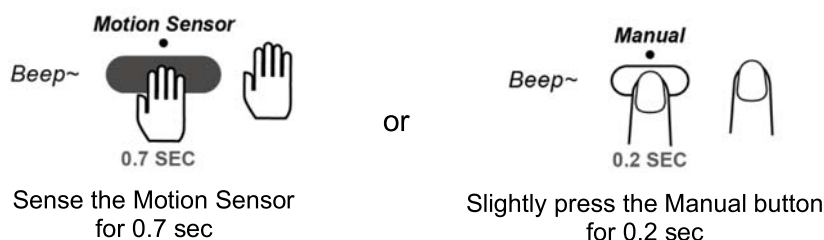

■ Standard Output

- A larger flow for general disinfection rinse

When the performance icon  is full, the ozone water output with the highest concentration of 6.0 ppm can be supplied immediately (output concentration range: 6.0 ~ 0.6 ppm; flow rate: 200 L/hour), the continuous water output time is 5 minutes. Press or sense any button to stop giving the output.

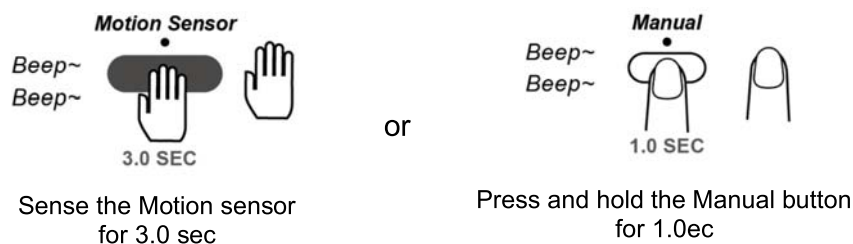



■ Digital Sensor Faucet (SF-100) Operation

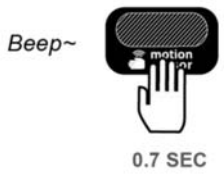

After the faucet is connected, the control panel on the main device will be invalid.

■ Use the “motion sensor”

1. Sense the Motion sensor for 0.7 sec

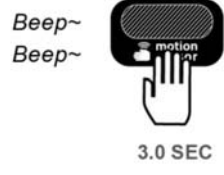

	<p>When the performance icon  is full, the ozone water output with the highest concentration of 10.0 ppm can be supplied immediately (output concentration range: 10.0 ~ 1.0 ppm; flow rate: 100 L/hour), the continuous water output time is 5 minutes. Press or sense any button to stop giving the output.</p>
---	--

2. Sense the Motion sensor for 3.0 sec

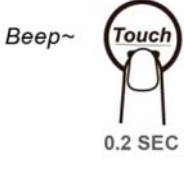

	<p>When the performance icon  is full, the ozone water output with the highest concentration of 6.0 ppm can be supplied immediately (output concentration range: 6.0 ~ 0.6 ppm; flow rate: 200 L/hour), the continuous water output time is 5 minutes. Press or sense any button to stop giving the output.</p>
--	--

■ Use the “Touch” Button

1. Slightly press the “Touch” Button

	<p>When the performance icon  is full, the ozone water output with the highest concentration of 10.0 ppm can be supplied immediately (output concentration range: 10.0 ~ 1.0 ppm; flow rate: 100 L/hour), the continuous water output time is 5 minutes. Press or sense any button to stop giving the output.</p>
---	--

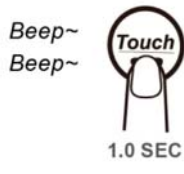
2. Press and hold the “Touch” Button for 1.0 sec

	<p>When the performance icon  is full, the ozone water output with the highest concentration of 6.0 ppm can be supplied immediately (output concentration range: 6.0 ~ 0.6 ppm; flow rate: 200 L/hour), the continuous water output time is 5 minutes. Press or sense any button to stop giving the output.</p>
---	--

4.3 Other Functions

Pre-Filter Monitoring Program Setting & Life Reset

By default, CDU is available with "Pre-Filter Service Indicator" - the "Life Meter" on the right side of screen that can assist user to monitor the replacement cycle of the filter(s) (or the cartridge(s)). There are total of ten monitoring programs based on treatment capacity for options, from "PF00" to "PF09". If monitoring is not required, select "PF00" to deactivate the function. Otherwise, select your option based on the capacity provided by the manufacturer of the product:

- PF00 : ∞ L (∞ gal)
- PF01 : 5,000 L (1,320.9 gal)
- PF02 : 10,000 L (2,641.8 gal)
- PF03 : 15,000 L (3,962.7 gal)
- PF04 : 20,000 L (5,283.6 gal)
- PF05 : 25,000 L (6,604.5 gal)
- PF06 : 30,000 L (7,925.4 gal)
- PF07 : 35,000 L (9,246.3 gal)
- PF08 : 40,000 L (10,567.2 gal)
- PF09 : 45,000 L (11,888.1 gal)



The monitored remaining lifecycle for the pre-filter is displayed on the right side "Life Meter" on the display. Each segment represents 10% of the monitored remaining lifecycle.

Pre-Filter Service Indicator

Follow below instruction to modify the Pre-Filter Service Indicator Setting /or to reset the life after cartridge replacement:

1. During system standby, press and hold the lower button for 30 seconds to enter the Pre-Filter Service Indicator Setting.
2. Use the upper sensor to select program from PF00 to PF09 according to your filter capacity.
3. Press lower button to save the setting and reset the remaining life data.

Infrared Sensing Sensitivity Adjustment

Follow below instruction to modify the sensitivity of the infrared sensor:

1. During system standby, press and hold the lower button for 40 seconds to enter the Infrared Sensing Sensitivity Adjustment Setting.
2. Press lower button to select sensitivity from Sn00-Sn09, the later the stronger. Factory default is Sn04.
3. Use the sensor to save the setting and resume standby mode.

4.4 Validation

Ozone has a short half-life and leaves no residues. Therefore, to overcome ozone's hard-to-detect properties, BioSure provides a simple titration kit – OM-100 (**NOT included** in the accessories) to ensure your unit is actively providing ozone for disinfection and sanitation in various applications you want.

OM-100 includes easy-to-use dropper bottle containing dissolved ozone titration reagent to quickly and effectively establish measures of the presence of dissolved ozone in the sample. Just pour 200 ml of ozonated water into a beaker, combine use of titration until light blue is presented. This measures the ozone concentration in the sample instantaneously by use of drops.

The following sequence of steps is to be followed for OM-100 in product performance validation:

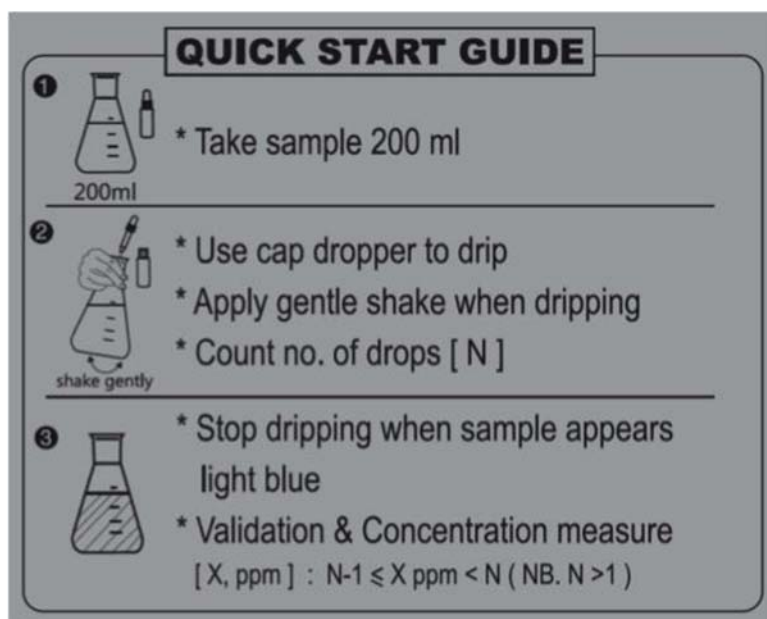

Quick Start Guide on OM-100 Bottle

1. Take sample of 200 ml using a beaker.
2. Apply the OM-100, drop by drop, shake or stir the sample after each drop, until light blue is present in the sample.
3. If you have apply 4 drops (for example) to make the sample become light blue, meaning the concentration of sample is between 3 to 4 ppm. (Greater than 3, not enough for 4).

One drop represents 1 ppm of dissolved ozone (by measuring the oxidation).

Note: Sample is taken from the output after pressing control buttons. You may take 3 – 5 samples at a time for average.

Please contact your local BioSure dealer for the OM-100 from BioSure.

5. Maintenance & Service

Regular service should be performed to avoid damage to the system, more costly repairs and to keep the warranty active.

5.1 System Service

Standard service cycle for your CDU is a rule of thumb under the following conditions:

- System **MUST** remain connected to water and power supply at all times.
- Municipal water (or equivalent quality) is used for input.
- Operating room temperature is in accordance with products instructions.
- Operating input water temperature and the supply pressure are in accordance with products instructions.

It is recommended to replace pre-filter every 12 months and replace all consumable parts every 24 months. The related items as replacement in the service and the servicing cycles are as follows:

<i>Consumable Parts Life Cycle</i>	
Name of Parts	Servicing Cycle
EOG Pre-Filter	1 year (depending on usage)
Deionization (DI) Assembly	Approx. 24 - 36 Months (Depending on usage, environmental temperature and water quality.)
Reverse Osmosis (RO) Assembly	
Electrolytic Ozone Generator (EOG)	
Off-Gas Destructor	
System Cooling Fan	

Service Notification

The CDU shows various Service Codes as notifications to users when standard service is required. The information is displayed on the display screen. Please contact your regional BioSure Dealer for service arrangements when the code(s) are present.

For Remaining lifecycle of any consumable part that is recorded, the unit will provide service notification once the service or replacement is required. The Service

Notification will be displayed in two different modes according to the degree of urgency: "**2% Remaining Notification**" and "**Life Ending Notification**":







2% Remaining Notification

In this mode, "🔧" is flashing in slow mode, 2 beeps are sounded when pressing any key. At this time, the user should contact the local BioSure dealer to schedule a service and part replacement within 3-week time.

Life Ending Notification

In this mode, 10 second buzz will be sounded when the state occurs, "ERROR" is flashing in fast mode, "🔧" lights up, 5 beeps are sounded when pressing any key. All functions are suspended. At this time, the user should contact the local BioSure dealer to schedule a service and part replacement IMMEDIATELY.



The coding for each service requirement and the interpretation is listed as follows:

Service Code	Service Requirement Interpretation
	<p><i>Wording translation: S11</i> <i>Coding Interpretation: Replace EOG Pre-Filter</i></p>
	<p><i>Wording translation: S31</i> <i>Coding Interpretation: Replace Reverse Osmosis (RO) module</i></p>
	<p><i>Wording translation: S32</i> <i>Coding Interpretation: Replace Deionizer (DI) module</i></p>
	<p><i>Wording translation: S34</i> <i>Coding Interpretation: Replace Off-Gas Destructor</i></p>
	<p><i>Wording translation: S38</i> <i>Coding Interpretation: Replace all Fans</i></p>
	<p><i>Wording translation: S39</i> <i>Coding Interpretation: Replace Input Hose (EOG Pre-Filter pipes for both input & output)</i></p>
	<p><i>Wording translation: S71</i> <i>Coding Interpretation: Replace EOG Cell</i></p>

5.2 Troubleshooting

Error Notification

For following detectable errors, once detected, the codes will be displayed on the display panel:

Error Code	Error Interpretation
	<p><i>Wording translation: E10</i></p> <p><i>Error Interpretation: EOG Cell Fails.</i></p> <p><i>Alarm beeps for 10 seconds. All functions are suspended.</i></p>
	<p><i>Wording translation: E45</i></p> <p><i>Error Interpretation: EOG water refilling timeout</i></p> <p><i>Alarm beeps for 10 seconds. All functions are suspended.</i></p>
	<p><i>Wording translation: E75</i></p> <p><i>Error Interpretation: Power Supply failure or Power disconnection exceeds 72 times a year recorded.</i></p> <p><i>All functions are suspended.</i></p>

Power Disconnection Statistical Number Counts Notification

To maintain the system's best performance, power must be connected at all times. Unless in necessary situations, such as due to servicing activities or supply outage that may occur occasionally and/or unexpectedly, attempt and care should be made in order to avoid any man-made incidence of power off. Disconnecting the power frequently and too many times may cause unexpected impacts on the EOG module and will result in degradation to the product performance.

Note. To keep the warranty valid, power off should not exceed 72 times in an operating year (6 times per month).

Associated with the accumulated power disconnection number counts, the system notification will be provided with two phases:

Phase 1: Reminder notification to accumulated power off times – A reminder to the recorded number at the time

An incident reminder will be displayed once a "monthly notifying point" is reached. At this stage, accumulated number of power off incident at the time will be displayed on the panel, icon "i" and "🔌" will blink slowly, and Icon "🔊" will light on. This

reminder is provided with intention to bring up attention to users with respect to the fact that the accumulated number of power off incident has exceeded the acceptable number based proper maintenance.

This status comes after the completion of re-start protection period (30 min) and can be removed and returned to normal standby status by pressing any key. At this point, users should read the displayed number on the panel, and call the dealer to discuss and understand the circumstance if necessary. Most importantly, following effort should be made in order to try to avoid any further incident of man-made power off.

Determination of monthly notifying point:



The monthly notifying point will be determined by system to the recorded number of actual power off according to the following statistical principle:

Monthly notifying point = $6 \times N$ (times) [N.B.: N stands for operating month(s), $N \geq 1$]

For example, the incident is notified once the 6th time of power off occurs within the first operating month in total, or the 12th time within the second operating month, and so on for the following months.

Considering proper maintenance, the acceptable number of power off incident averaged in each operating month is 6 times.

Phase 2: Warning to power off limit – A notification to the limitation reached and invalid warranty on the EOG cell, i.e., 72 times.

For 72 times (or more) power off in an operating year recorded by the unit, a "E75" as notification will be displayed on the panel, together with the accumulated number of incident at the time displayed one after the other. Similar to phase 1, icon "" and "" will blink slowly, and Icon "" will light on. All these displays come after the completion of re-start protection period (30 min) and can be removed and returned to normal standby status by pressing any key.

After removing the notification display, despite the icon "" will remain blinking slowly, all functions will still be available for use after the status removed. However, impacts on the EOG module may have been resulted and degradation to the performance may have occurred. At this point, the warranty has become partially invalid. This is for your reference that you should call your dealer to discuss your usage and discuss service if necessary.

Please check out the following troubleshooting suggestions before calling for repair.

<i>Symptom</i>	<i>Possible Cause</i>	<i>Resolution</i>
Display panel does not light up.	Is the power cord plugged in correctly to an active outlet?	Plug the power cord in properly.
	Electronic failure	Unplug the unit and contact your dealer to arrange service.
Water does not flow out or the unit has stopped functioning.	Is the source water valve line closed?	Turn the water supply valve on.
	Is the source water line connected?	Be sure the water supply hose is connected properly.
	Is the hose bent?	Be sure the water line is not bent.
	Is the water pressure too low?	Replace the Pre-Filter. Contact your dealer to arrange service.
Water is leaking from the hose at the attachment.	Check to see if the hose is disconnected.	Connect the hose to the attachment.
Water is leaking from inside the unit.	Unknown.	Unplug the unit and contact your dealer to arrange service.
The water has a strange odor or tastes bad.	Has the unit been unused for a long time?	Let ozonated water flow through the unit for 15 minutes or more. If still doesn't work, contact your dealer to arrange service.
There is a strange noise coming from the unit.	Unknown.	Unplug the unit and contact your dealer to arrange service.
Display Code: E10 All functions suspended.	Faulty EOG Module	Contact your dealer to arrange service.
Display Code: E45 All functions suspended.	EOG water refilling timeout by low water pressure.	Correct input water pressure and then press or sense any button to re-start the unit.
	EOG water refilling timeout by EOG Pre-Filter jammed.	Clean or replace as needed and then press or sense any button to re-start the unit.
	EOG water refilling timeout by any case of water supply got cut off. / Unknown.	Recover water supply and then press or sense any button to re-start the unit. If error message remains, please contact your dealer to arrange service.
Display Code: E75 Warranty void for EOG Cell.	Power interruptions or re-start exceeds 72 times a year.	Press or sense any button to return to normal stand-by, but contact your dealer for further information and performance check.

5.3 System Background Platform

The System Background Platform is a restricted function defined for service purpose only and should only be used by a qualified technician. Functional features available under this operation platform are structured in two phases, including Part Lifetime Reset and Configuration Index:

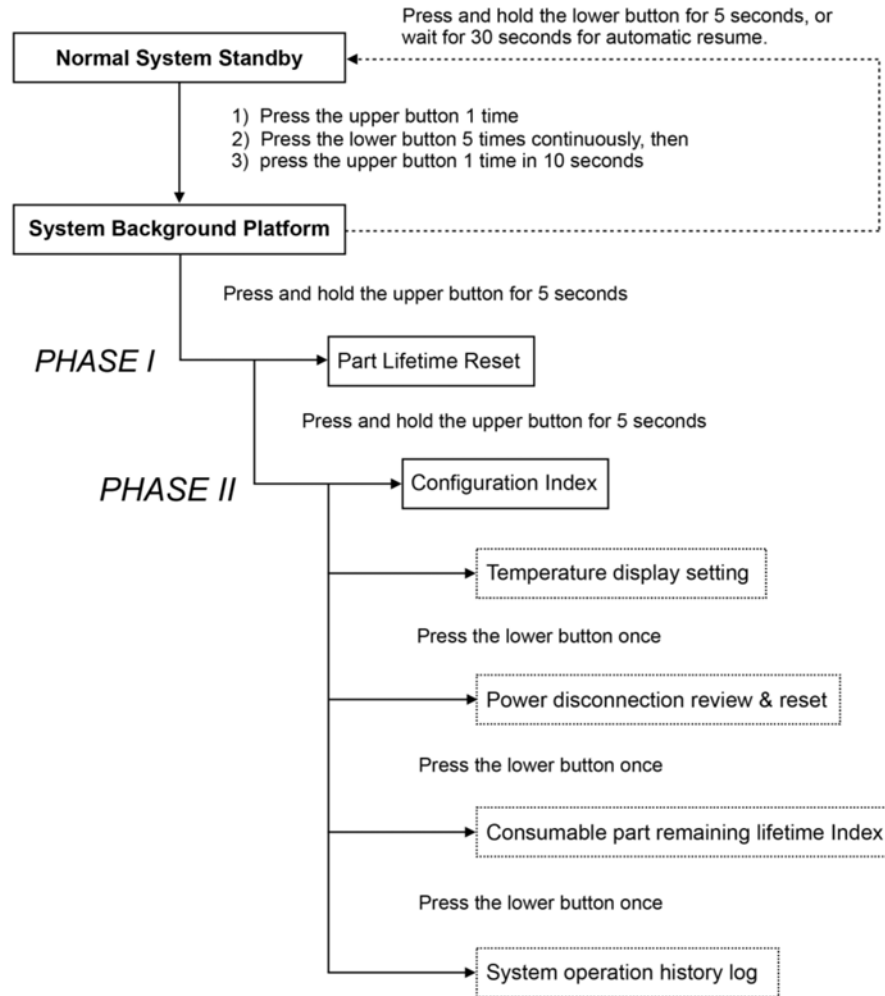

To enter the System Background Platform, first press "Upper Button" 1 once (x1). Then, press "Lower Button" 5 times (x5) continuously and "Upper Button" once (x1) in 10 seconds under normal system standby. A successful entry of the System Background Platform can be identified on the display panel by observing a solid light ⓘ and flashing **READY**.

To leave "System Background Platform" and return to "Normal System Standby" phase, press and hold "Lower Button" for 5 seconds, or wait for 30 seconds for automatic resume.

PHASE 1

- Part Lifetime Reset

The mode of Part Lifetime Reset for "System Background Platform" allows the remaining life of each consumable part to be restored - resume to 99% from whatever it was.

To reset the remaining life for consumable parts:

1. Enter "System Background Platform" first.
2. Press and hold "Upper Button" for 5 seconds, one beep will sound, and the system will activate the mode of "Part Lifetime Reset". At this point, system panel will display "0000 " for input. To restore the remaining life of each consumable part a unique code for each part will be required (Contact your local BioSure dealer for details).
3. To input the code, follow input sequence from right to left, use "Upper Button" to select numbers from 0 to 9 on the flashing digit and use "Lower Button" to switch the flashing digit to the next one left.
4. After the completion of code input, proceed to press "Lower Button" once (x1). With a correct code input, the matching item with existing remaining life will be displayed in blinking mode as an indication. Otherwise, if an incorrect code was inputted, the system will return back to the preliminary status of "System Background Platform".
5. Proceed to press "Lower Button" once again (x1) to complete the reset, and the system will return to the mode of "Part Lifetime Reset" displaying "0000 " for next input.

PHASE 2

- Configuration Index

The mode of "Configuration Index" for "System Background Platform" allows the following system information to be configured for different settings and/or to be viewed:

- Temperature Display Switch
- Power Disconnection Review & Reset
- Consumables Service Life Index
- System Operation History Log

Temperature Display Switch

The system measures internal temperature and displays it on the display screen for user's reference. The temperature display as a primary presentation during system's standby comes as default in any unit. Standard temperature display is in degrees Celsius (°C); degrees Fahrenheit (°F) is optional. "Temperature Display Setting" is located at the first sequential operation order in the phase II of "System Background Platform". Follow below instructions to change the display of temperature between in degrees Celsius (°C) and degrees Fahrenheit (°F):

1. Enter "System Background Platform" and activate the mode of "Part Lifetime Reset" first.
2. Under the mode of "Part Lifetime Reset" the system displays " ". At this point, again press and hold "Upper Button" for 5 seconds to enter the phase II. A successful entry of the System Background Platform phase II - "Configuration Index", can be identified on the display panel by observing a blinking °C or °F, depending upon whichever the existing setting was.
3. Press "Upper Button" to switch the "Temperature Display Setting".
4. After the completion of setting, press and hold "Lower Button" for 5 seconds to resume "Normal Standby" mode, or press "Lower Button" once again (x1) to proceed to "Operational Power Disconnection Review & Reset" segment.

Power Disconnection Review & Reset

All cases of power disconnection are recorded by the system, including those happened on the user's end due to operational incident and some due to service. Accumulated "Operational Power Disconnection" is associated with error code E75 and critical to warranty validation. Thus, for those accumulated due to servicing or repairing the records should be removed before return of unit. The function of "Operational Power Disconnection Review and Reset" will allow the records to be checked and deducted.

To review the records:

1. Enter "System Background Platform" and activate the mode of "Part Lifetime Reset" first.
2. Under the mode of "Part Lifetime Reset" the system displays " ". At this point, again press and hold "Upper Button" for 5 seconds to enter the phase II. A successful entry of the System Background Platform phase II - "Configuration Index", can be identified on the display panel by observing a blinking °C or °F, depending upon whichever the existing setting was.
3. Press Lower Button once (x1) to skip "Temperature Display Setting" and enter "Operational Power Disconnection Review and Reset" segment. Displayed number indicates the existing record of "Operational Power Disconnection".

To reset the records or to leave:



1. Following procedures above, use of Upper Button will allow the number to be deducted. Press "Upper Button" once (x1) to deduct the number for 1.
2. After the completion of review or reset, press and hold "Lower Button" for 5 seconds to resume "Normal Standby" mode, or press "Lower Button" once again (x1) to proceed to "Consumable Part Remaining Lifetime Index" segment.





Consumables Service Life Index

The system records the remaining lifetime of each consumable part for purpose of service check. The information can be checked through the following operations:

1. Enter "System Background Platform" and activate the mode of "Part Lifetime Reset" first.
2. Under the mode of "Part Lifetime Reset" the system displays " ". At this point, again press and hold "Upper Button" for 5 seconds to enter the phase II. A successful entry of the System Background Platform phase II - "Configuration Index", can be identified on the display panel by observing a blinking °C or °F, depending upon whichever the existing setting was.
3. Press "Lower Button" two times (x2) to skip "Temperature Display Setting" and "Operational Power Disconnection Review and Reset" and enter "Consumable Part Remaining Lifetime Index" segment.
4. Use Upper Button to review the records. Press "Upper Button" once (x1) to switch to the next one.
5. After the completion of check, press and hold "Lower Button" for 5 seconds to resume "Normal Standby" mode, or press "Lower Button" once again (x1) to proceed to "Operation History Log" segment.

From the left, the first two digits are the item indicated by codes, and the last two indicate the remaining service life of the part in percentage (%). The codes are interpreted as follows:

Part Coding	Coding Interpretation
	<p><i>Wording translation: OG99</i> <i>Indicated part: Electrolytic Ozone Generator (EOG)</i> <i>Interpretation: Remaining life 99% for EOG-Cell</i></p>
	<p><i>Wording translation: ro99</i> <i>Indicated part: Reverse Osmosis (RO) Module</i> <i>Interpretation: Remaining life 99% for RO Module</i></p>

	<p><i>Wording translation: dl99</i> <i>Indicated part: Deionizer (DI) Module</i> <i>Interpretation: Remaining life 99% for DI Module</i></p>
	<p><i>Wording translation: du99</i> <i>Indicated part: Off-Gas Destructor</i> <i>Interpretation: Remaining life 99% for Off-Gas Destructor</i></p>
	<p><i>Wording translation: Fn99</i> <i>Indicated part: System Cooling Fan</i> <i>Interpretation: Remaining life 99% for Fan(s)</i></p>
	<p><i>Wording translation: IP99</i> <i>Indicated part: Input Hose (IP)</i> <i>Interpretation: Remaining life 99% for IP</i></p>

System Operation History Log

The system records operation history as long as the power is on. "Operation History Log" allows the technician to know the system's working conditions and existing firmware version. The log records will be provided with total 20 digits of code in sequential groups of 5, including information for service reference as follows:

- Product model (in first 4 digits)
- Total operation hours (the following 5 digits)
- Total power disconnection counts (the following 4 digits)
- Total EOG water filling failure counts (the following 3 digits)
- System program code (the last 4 digits)

How to access the Operation History Log:

1. Enter "System Background Platform" and activate the mode of "Part Lifetime Reset" first.
2. Under the mode of "Part Lifetime Reset" the system displays "0000". At this point, again press and hold "Upper Button" for 5 seconds to enter the phase II. A successful entry of the System Background Platform phase II - "Configuration Index", can be identified on the display panel by observing a blinking °C or °F, depending upon whichever the existing setting was.
3. Press "Lower Button" three times (x3) to skip "Temperature Display Setting", "Operational Power Disconnection Review and Reset" and "Consumable Part Remaining Lifetime Index" and enter "Operation History Log" segment.

4. Use "Upper Button" to review the data in each subsequent group. Press "Upper Button" once (x1) to switch groups in order.
5. After the completion of check, press and hold "Lower Button" for 5 seconds to resume the "Normal Standby" mode, or press "Lower Button" once again (x1) to return to "Temperature Display Setting " segment.

How to read and interpret the Operation History Log:

1. Note down all the codes with total 20 digits in order.
2. Identify information from sequential codes:

GROUP

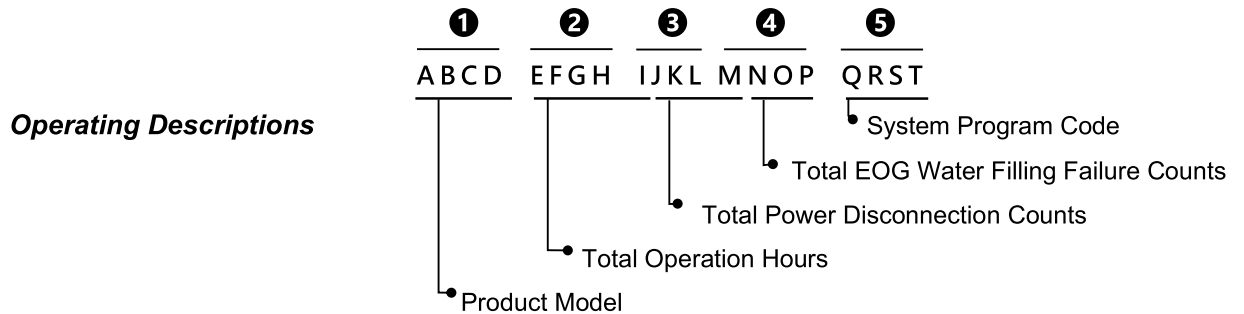

Code Wording Index for Alphabet

Display					
Alphabet	o	i	r	H	4
Interpretation	0	1	2	3	4
Display					
Alphabet	F	d	G	E	c
Interpretation	5	6	7	8	9

Example :

Coding we noted: FioH, ooFi, Eooi, FooG, oroc
Translate the Coding: 5103, 0051, 8001, 5007, 0209
Rearrange the Coding: 5103, 00518, 0015, 007, 0209

We get:

- Product Model: EOS7131-CD
- Total Operation Hours: 518 hours
- Total Power Disconnection Counts: 15 times
- Total EOG Water Filling Failure Counts: 7 times
- System Program Code: V209

MEMO

BioSure **PROFESSIONAL**

Biotek Environmental Science Ltd.

Address: 5F, 98 Xingde Rd., Sanchung Dist., New Taipei, 24158 Taiwan

Telephone: +886 2 8511 1048

Webpage: www.besgroups.com